

# Nasal Cannula

## Home Oxygen Instructions for Use

Please read and follow the Instructions for Use prior to using your nasal cannula for your home oxygen therapy.

The Nasal Cannula is used to deliver supplemental oxygen to patients who have a prescription for home oxygen therapy. Prior to home use, you and/or your caregiver should receive instructions from a trained healthcare professional on how to safely use your nasal cannula while on oxygen.

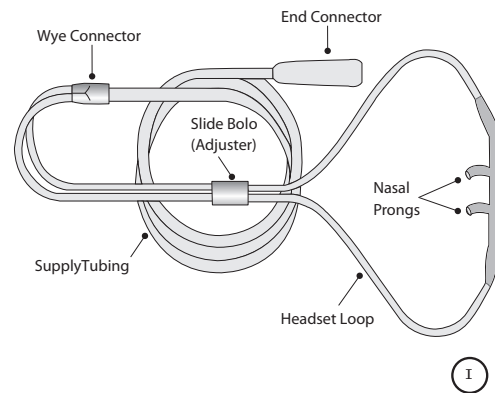

Nasal Cannulas are disposable and for single-patient use.

Nasal Cannulas are intended for use in the home, outpatient, extended care, transport and hospital environments.

Nasal cannulas are available in sizes from infants to adults. The nasal cannulas are available in different styles with various lengths of supply tubing. Some styles may have liter flow limitations, which will be stated on the product label.

### Who to Contact

For additional questions or comments about your Nasal Cannula, contact Salter Labs customer care at 800-421-0024, Mon–Fri 8 AM to 5 PM CST.; or email [Customercare@salterlabs.com](mailto:Customercare@salterlabs.com).

For questions about your home oxygen equipment, contact your local home care provider.

If your physical symptoms worsen or you experience a sudden change in your condition (e.g., increased shortness of breath, fever, dizziness), or if you develop a hypersensitivity (severe rash) to your nasal cannula, call your doctor.

If you experience severe physical problems (e.g., chest pains, cannot breath), call 911.

# Instructions for Use (continued)

## Application

1. Wash hands. Remove nasal cannula from package.
2. Attach end connector to oxygen source, e.g., oxygen extension tubing or oxygen flow control outlet.
3. Adjust flow control knob to the prescribed liter flow. Check for gas flow from the nasal prongs.
4. a–Position the nasal cannula with the nasal prongs facing upward and curved toward the face.  
b–Insert the two nasal prongs into the nostrils.
5. a–Wrap the headset loop up and over both ears.  
b–Alternative placement: Secure headset loop behind your head.
6. a–Squeeze the sides of the bolo and glide the bolo up under your chin.  
b–Leave enough space to fit at least two fingers between the bolo and chin.

## Care and Cleaning Instructions

1. Once a day, use a clean damp cloth to wipe off the nasal prongs and headset tubing.
2. Do not use strong or scented detergents, degreaser, alcohol based products or lotion soaps to clean your nasal cannula.
3. Do not sterilize your nasal cannula.
4. Discard and replace your nasal cannula when it becomes soiled, discolored or the prongs become stiff. Recommend replacing nasal cannula at least once every 14 days. Do not use your nasal cannula for more than 30 days.

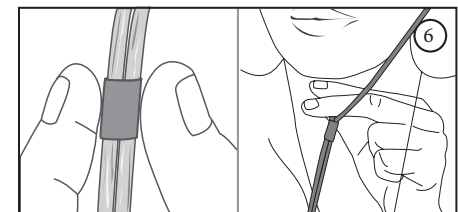
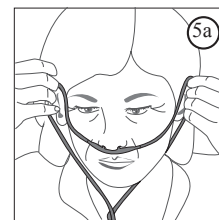
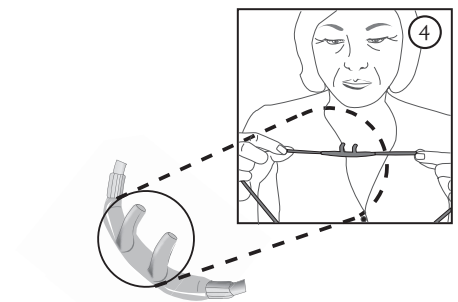
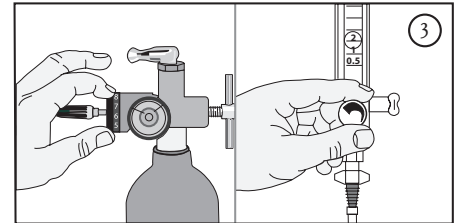
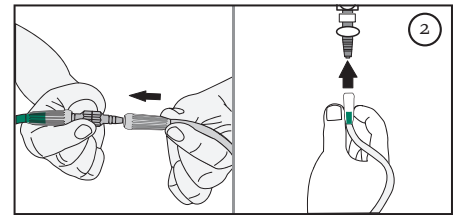

(Continued on the next page)

## Instructions for Use (continued)

### Safety Precautions

- Oxygen is a nonflammable gas, but does support combustion. Follow your homecare provider's instructions for the care and safe operation of your oxygen delivery system (e.g., oxygen cylinder, oxygen concentrator, liquid oxygen).

- **Do not smoke or allow anyone to smoke around you.** This includes, but limited to, cigarettes, pipes, cigars, and electronic cigarettes (vapors).



- **Keep oxygen equipment at least 6 feet away from flames** or any heat source, for example, fireplaces, stoves, barbeque grills, and space heaters.

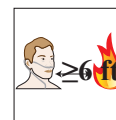

- Do not use petroleum based products or oil-based creams and lotions in or around your nose. For example, don't apply Vaseline around or in your nares.



- Do not use flammable products such as aerosol sprays or cleaning products while wearing your nasal cannula or around your oxygen source.



- Avoid using electrical equipment that may cause a spark, for example, electric razor, blow-dryer or curling iron.



- Use oxygen as prescribed by your doctor.
- The total length of your nasal cannula and oxygen supply tubing should not exceed 57 feet to ensure there is enough pressure to deliver prescribed oxygen flow rate.
- Do not kink, bend or tie your oxygen tubing,
- Do not place anything on your tubing that may obstruct flow.
- Keep excess tubing loosely coiled and out of the way to prevent tripping on oxygen tubing.
- Do not place your oxygen tubing or nasal cannula under blankets, bedsheets, rugs, etc.
- Use caution to prevent your oxygen tubing from becoming entangled in your furniture.
- Keep an extra nasal cannula and other oxygen supplies available for use.
- Do not let children or pets play with your nasal cannula and oxygen equipment.
- Recommend use of swivel adapter for nasal cannula and supply tubing longer than 14 feet.
- If using humidification, add a water trap to collect excess moisture in the supply tubing.

# Instructions for Use (continued)

## Troubleshooting Tips

Problem	Possible Cause	Corrective Action
No oxygen flow from nasal prongs	<ol style="list-style-type: none"> <li>1. Cannot feel the airflow in your nostrils.</li> <li>2. Flow control valve is not turned on.</li> <li>3. Oxygen system is not functioning properly or oxygen container is empty.</li> <li>4. The nasal cannula is disconnected from oxygen device or supply tubing.</li> <li>5. Nasal cannula or oxygen tubing kinked or blocked.</li> </ol>	<ol style="list-style-type: none"> <li>1. Check air flow by placing prongs next to hand or place nasal prongs into a small container of clean water. Bubbles will appear if there is oxygen flow.</li> <li>2. Set flow control to prescribed setting.</li> <li>3. Switch to backup oxygen source and contact your homecare provider.</li> <li>4. Reconnect oxygen tubing. Ensure all tubing connections are tight and secure.</li> <li>5. Inspect cannula and oxygen tubing for kinks or damage. Ensure nothing is placed on top the tubing.</li> </ol>
Water in nasal cannula or oxygen supply tubing	<ol style="list-style-type: none"> <li>1. Humidifier bottle overfilled, or bottle has tipped over.</li> <li>2. Water trap is full</li> <li>3. High humidity environment, or sudden drop in temperature.</li> </ol>	<ol style="list-style-type: none"> <li>1. Pour out the excess water. Ensure that the humidifier bottle is upright.</li> <li>2. Empty water trap.</li> <li>3. Consider adding a water trap to your oxygen supply tubing.</li> </ol>
Nasal dryness or irritation	<ol style="list-style-type: none"> <li>1. Gas flow is dry.</li> <li>2. No humidifier is being used.</li> </ol>	<ol style="list-style-type: none"> <li>1. Use normal saline spray or water soluble ointment, (i.e., AYR Saline Nasal Gel) to moisten the inside your nostrils. If condition worsens, contact your doctor.</li> <li>2. Contact your doctor or homecare provider to request humidification.</li> </ol>
Soreness or irritation around ears	<ol style="list-style-type: none"> <li>1. Headset tubing too tight.</li> <li>2. Tubing pressing against skin.</li> </ol>	<ol style="list-style-type: none"> <li>1. Loosen headset tubing.</li> <li>2. Place a cotton padding or cushion (i.e., EZ- Wrap) under headset tubing.</li> </ol>
Skin rash and/or sores caused by nasal cannula	<ol style="list-style-type: none"> <li>1. Sensitivity or reaction to nasal cannula material.</li> <li>2. Nasal cannula is dirty.</li> <li>3. Cleaning detergent used to clean nasal cannulas may be absorbed into the plastic and can irritate the skin.</li> <li>4. Nasal prongs are stiff causing nasal irritation and discomfort.</li> </ol>	<ol style="list-style-type: none"> <li>1. Contact your health care provider and/or doctor.</li> <li>2. Wipe nasal cannula down with a damp cloth to remove oil and debris. If detergent is needed use a mild soap and rinse well.</li> <li>3. Replace cannula. When cleaning cannula only use a damp cloth. Do not use strong detergents, disinfectants or oil based soaps.</li> <li>4. Replace nasal cannula. Do not use a nasal cannula for more than 30 days.</li> </ol>
Nasal prongs and tubing is stiff	<ol style="list-style-type: none"> <li>1. Most nasal cannulas are made with a PVC material, which may harden with age and extended use.</li> <li>2. Alcohol based cleaners may harden the PVC material</li> </ol>	<ol style="list-style-type: none"> <li>1. Replace your nasal cannula</li> <li>2. Replace your nasal cannula</li> </ol>